

RIBE®

FASTENING SYSTEMS

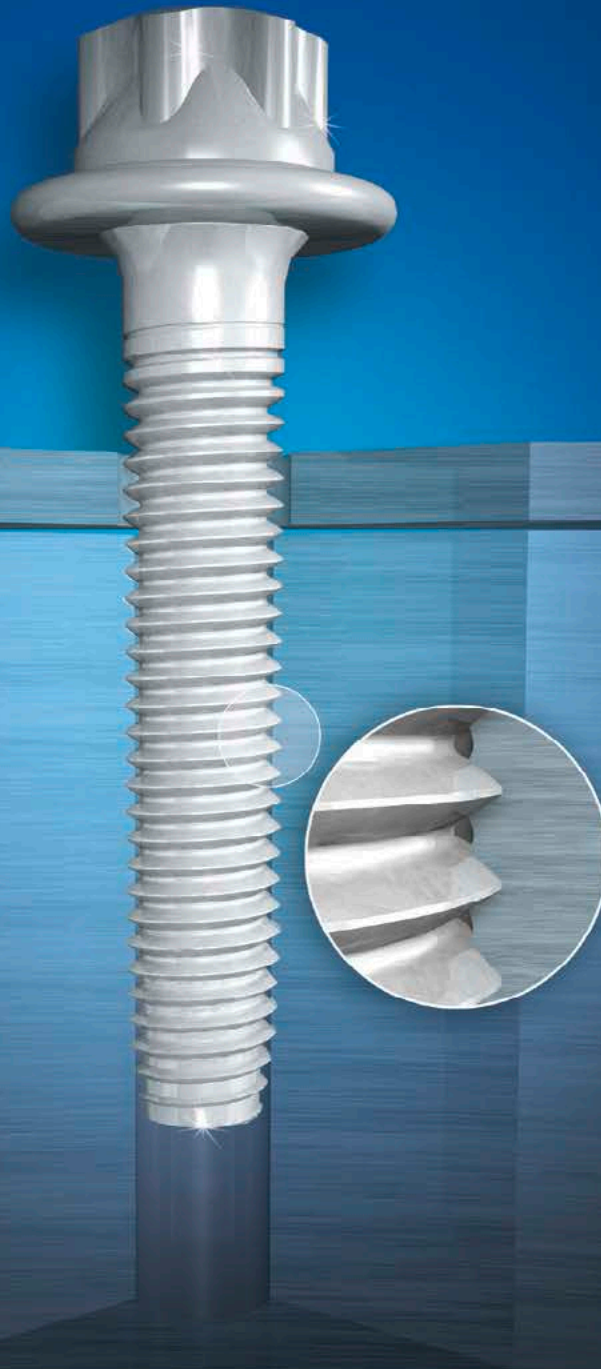

RIBE® THREAD-FORMING SCREWS – DIRECT FASTENING IN STEEL,
CAST IRON, ALUMINUM, SHEET METAL, MAGNESIUM AND PLASTIC



THREAD-FORMING SCREWS – CUT COSTS WITH DIRECT FASTENING

Thread-forming screws create their own mating thread by reforming the mating material during assembly. Direct fastening in components without an existing mating thread can substantially cut the overall cost of mechanical fastening in many cases. Particularly the process costs can be reduced by using thread-forming screws, as no thread cutting or thread forming is necessary and no metal chips are produced. The screws are inserted directly into stamped, drilled, cast or lasered holes. Thread-forming screws also offer definite advantages in terms of process reliability. The material hardening in the thread creates a higher proof load for the complete fastening. Because of the necessary insertion torque and the perfect fit between the screw and mating thread, the resistance to loosening is greater, which often makes it possible to dispense with screw locking devices.

RIBE® thread-forming screws have been designed specifically to meet the requirements of various applications and materials and are available in a broad range of geometries, materials and finishes. Direct fastenings always require an optimum interaction between component, fastener and assembly, so the screw must be perfectly designed for each application. An exact analysis of the fastening and the required properties is always recommended for high-load and special applications. Our Application Engineering Department will be pleased to help.

Materials and versions

All metals and plastics with sufficient ductility and a material strength of up to approx. 950 MPa are suitable as mating materials for direct fastenings. There is a fundamental difference between direct fastening in metals and plastics: For fastening in metals and especially steel, the screw needs to be extremely hard in the forming zone (achieved by quenching and tempering for high strength, CORFLEX® N case hardening, CORFLEX® I partial inductive hardening). The CORFLEX® versions enable thread-forming screws to be used for fastenings subject to high static and

dynamic loads. The thread profile corresponds to that of a metric thread. For fastening in plastics, slender, well-tapered flanks with a coarser pitch are more suitable. Quenched and tempered screws are sufficiently strong for these applications and special hardening of the surface layer is not necessary.

ADVANTAGES OF THREAD-FORMING SCREWS

Direct fastening with thread-forming screws has the following advantages

- 1 Thread formed without cutting.
- 2 No weakening of the mating thread area as no material is removed.
- 3 Lower costs as no thread-cutting or forming is necessary.
- 4 Immediate use of stamped, drilled or cast holes.
- 5 Higher strength of mating thread due to cold fixing.
- 6 Increased resistance to loosening eliminates the need for screw locking devices.
- 7 No damage to mating threads due to cross-threading during assembly.

Process chain using a **metric** screw.

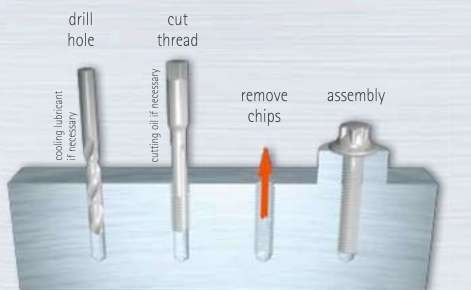

Shortened process chain using a **thread-forming** screw.

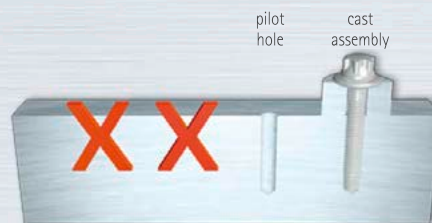

THREAD-FORMING SCREWS – OVERVIEW OF DIRECT FASTENING

▣ STEEL | CAST IRON | ALUMINUM

The TRIFORM™, TAPTITE II®, DUO-TAPTITE® and TAPTITE 2000® thread-forming screws are designed for direct fastening in metals. The TRIFORM™ screw is characterized by low thread-forming torque and good thread proof load at low production cost. The TAPTITE® screws have been specifically developed to meet extreme requirements for assembly performance and proof load.

▣ SHEET METAL

The TRIFORM™ DB is suitable for all applications with less extreme requirements for assembly performance. EXTRUDE-TITE® screws are characterized by a very low insertion torque due to their geometry. The TRIFORM™ DB HF screw has been developed specially for increased requirements in high-strength sheet metals with a strength of up to 950 MPa and in stainless sheet steel.

▣ MAGNESIUM

The use of high-strength RIBE® ALUFORM® aluminum screws is the optimum solution for reliable fastening of magnesium components. Prestressing force losses through additional thermally induced stresses are minimized by the very similar coefficients of thermal expansion and contact corrosion is avoided almost completely even with uncoated screws. The thread-forming version of these screws now also permits direct fastening of sufficiently ductile magnesium alloys.

▣ PLASTIC

RIBE® PR and PLASTOFORM screws are equally suitable for use in plastics. RIBE® PR is characterized by low-cost manufacture, whereas PLASTOFORM screws provide high pullout forces due to their flow-optimized geometry and are also suitable for brittle plastics.



STEEL CAST IRON ALUMINIUM		Cost-effective	Assembly performance	Proof load of fastening
	TRIFORM™	●	○	●
	TAPTITE II®	○	○	○
	DUO-TAPTITE®	○	●	●
	TAPTITE 2000®	○	●	●

SHEET METAL		Cost-effective	Assembly performance	Proof load of fastening
	TRIFORM™ DB	●	○	●
	TRIFORM™ DB HF	○	○	●
	EXTRUDE-TITE®	○	●	○

MAGNESIUM		Cost-effective	Assembly performance	Proof load of fastening
	ALUFORM®	○	○	○

PLASTIC		Cost-effective	Proof load of fastening
	RIBE® PR	○	○
	PLASTOFORM	●	●

● very suitable ○ suitable ○ less suitable



THREAD-FORMING SCREWS – FOR METAL COMPONENTS

The following screws have different thread-forming crests for creating the mating thread. The thread-forming crests have sharp flanks for rapid engagement of the screw during assembly and an out-of-round profile for forming the mating thread. These screws have a metric thread profile for interchangeability with screws with standard threads. For example, a screw with a metric thread can be used for subsequent repair if the original screw is not available.

TRIFORM™

- Low thread-forming torque
- High thread proof load
- Low-cost manufacture
- No license fees

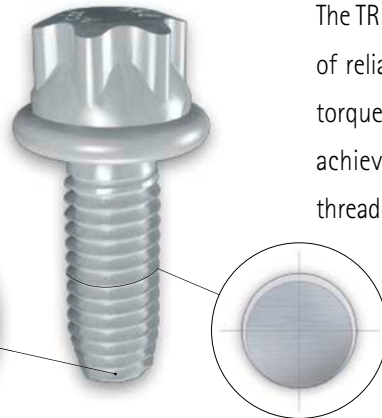

TRIFORM™

The TRIFORM™ screw, a RIBE® development with many years of reliable service, is characterized by low thread-forming torque and good thread proof load at a low price. This is achieved by the combination of a low-cost TRIFORM™ thread-forming crest and a round shank cross-section. Main applications: cost-optimized parts and mating thread materials with low reforming capacity.

TAPTITE II®

- Trilobular cross-section
- Very low thread-forming torque
- Short thread-forming crest
- Also suitable for large thread reach

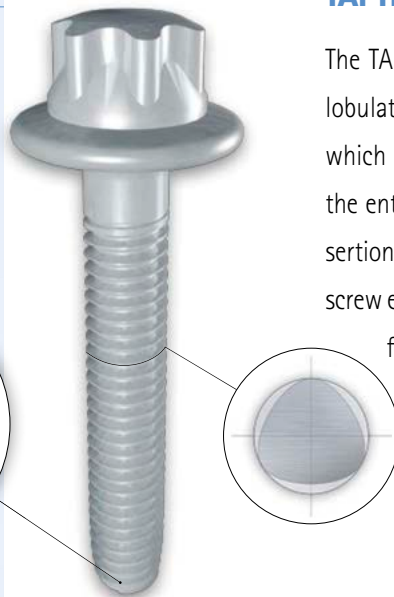
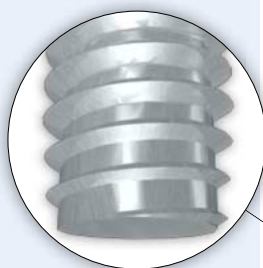

TAPTITE II®

The TAPTITE II® screw is characterized by a high degree of lobulation (out-of-roundness) of the shank cross-section, which achieves very low insertion torque. Lobulation over the entire length of the shank ensures consistently low insertion torque, even with a large thread reach. Although the screw engages with negligible axial contact force, the thread-forming crest of 2 to 3 turns is shorter and better than the requirements of DIN 7500-1.

DUO-TAPTITE®

The DUO-TAPTITE® screw has a thread-forming crest and a guide pin that facilitates finding and centering in the pilot hole for good axial alignment of the screw. The lobulation of the thread-forming crest is greater than that of the load-bearing shank, which provides low insertion torque combined with high axial proof load of the fastening (high stripping torque, high pullout forces).

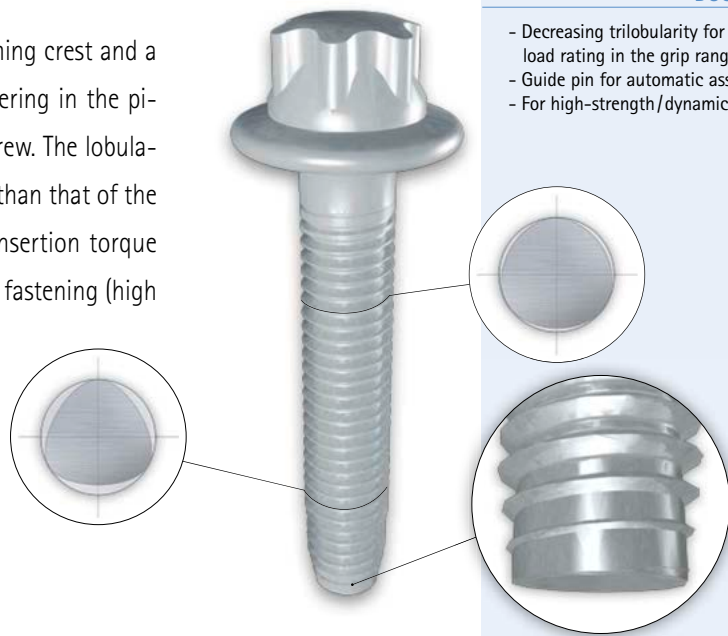

DUO-TAPTITE®

- Decreasing trilobularity for increased load rating in the grip range
- Guide pin for automatic assembly
- For high-strength/dynamic fastenings

TAPTITE 2000®

The TAPTITE 2000® screw combines the advantages of the TAPTITE II® and DUO-TAPTITE® in terms of mechanical properties and reduced costs. The trilobular thread profile with dual lobulation combined with the radius profile thread improves the insertion torque/stripping torque ratio. It also reduces the thread-forming torque by up to 30% compared with the DUO-TAPTITE®.

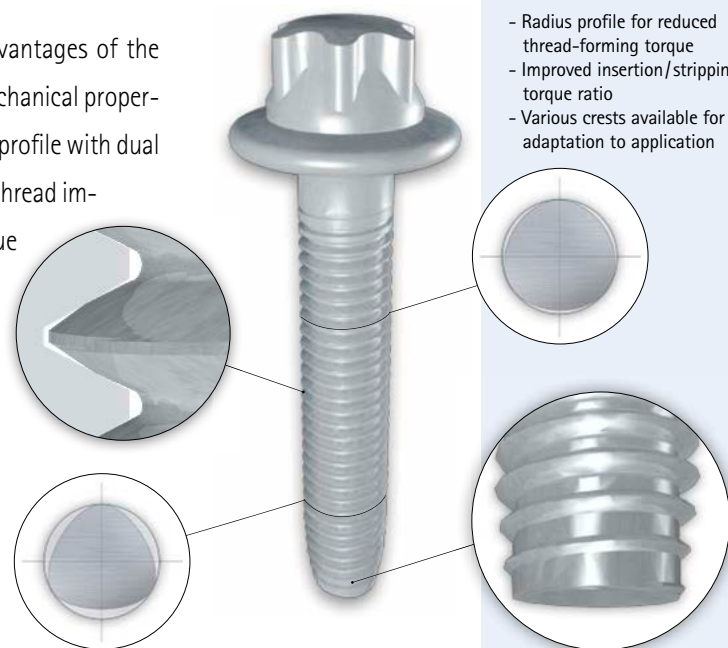

TAPTITE 2000®

- Radius profile for reduced thread-forming torque
- Improved insertion/stripping torque ratio
- Various crests available for optimum adaptation to application

TECHNICAL DATA – FOR METAL COMPONENTS

The tables shown here provide thread dimensions, suggestions for hole geometry for drilling, punching or casting, and guide values for insertion and tightening torque. The guide values shown apply equally to TRIFORM™, TAPTITE II®, DUO-TAPTITE® and TAPTITE 2000®. Due to the variety of possible parameters for material performance, surface and lubrication, the torque values stated should be regarded as guide values only. In case of critical component combinations such as low thread reach and mating thread materials of low ductility, we urgently recommend experimenting to determine the right values.

TRIFORM™

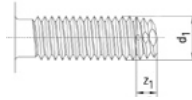

TRIFORM™ thread dimensions		
Thread	d ₁ max	z ₁ max
M 2.5	2.60	1.50
M 3	3.10	1.60
M 3.5	3.61	2.00
M 4	4.12	2.30
M 5	5.12	2.60
M 6	6.12	3.30
M 8	8.16	4.10
M 10	10.18	5.00

TAPTITE II®

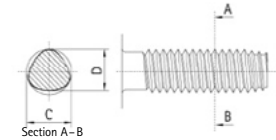

TAPTITE II® thread dimensions				
Thread	C		D	
	min	max	min	max
M 2	1.98	2.06	1.90	1.98
M 2.5	2.48	2.57	2.39	2.48
M 3	2.98	3.07	2.88	2.97
M 3.5	3.48	3.58	3.36	3.46
M 4	3.98	4.08	3.84	3.94
M 5	4.98	5.09	4.82	4.93
M 6	5.97	6.10	5.77	5.90
M 8	7.97	8.13	7.72	7.88
M 10	9.97	10.15	9.67	9.85
M 12	11.97	12.18	11.62	11.83

Transit holes: Guide values for insertion and tightening torque for TRIFORM™, TAPTITE II®, DUO-TAPTITE® and TAPTITE 2000® in Nm

Transit hole beyond thread-forming crest												
	M 2	M 2.5	M 3	M 3.5	M 4	M 5	M 6	M 8	M 10	M 12	M 14	M 16
Insertion torque** Values in Nm	0.1-0.2	0.2-0.4	0.3-0.7	0.5-1.1	0.7-1.6	1.5-3.5	2.5-6	7-15	15-30	25-52	35-70	55-115
Tightening torque 8.8*	0.4	0.7	1.3	1.9	2.8	5.5	9.9	23.4	45.9	78.3	130.5	198.0
Tightening torque 10.9	0.5	1.0	1.8	2.7	4.1	8.0	14.0	33.3	67.5	115.2	189.0	288.0
Tightening torque 12.9	0.7	1.2	2.1	3.2	4.7	9.4	16.2	38.7	78.3	135.0	216.0	342.0

Because of the many factors that can influence the process, such as mating thread material, hole diameter, thread reach, screw surface, lubrication conditions and screw geometry, the values shown are only intended as an approximate guide. The stated torque values apply only to screws with the corresponding hole geometry and sufficient thread reach.

Optimum assembly instructions must be determined by experiment.

* The values shown for 8.8 screws also apply to DIN 7500 screws.

** Even the highest insertion torque values are less than the maximum limits defined by DIN 7500.

DUO-TAPTITE®

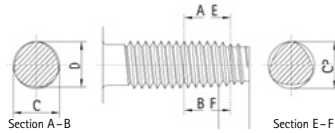

TAPTITE 2000®

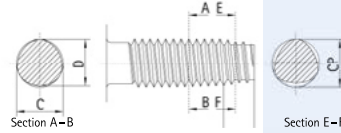

DUO-TAPTITE® thread dimensions

Thread	C		D		CP max
	min	max	min	max	
M 2	1.98	2.06	1.94	2.02	1.75
M 2.5	2.48	2.57	2.44	2.52	2.22
M 3	2.98	3.07	2.93	3.02	2.69
M 3.5	3.48	3.58	3.42	3.52	3.13
M 4	3.98	4.08	3.91	4.01	3.57
M 5	4.98	5.09	4.90	5.01	4.51
M 6	5.97	6.10	5.87	6.00	5.38
M 8	7.97	8.13	7.85	8.00	7.23
M 10	9.97	10.15	9.82	10.00	9.07
M 12	11.97	12.18	11.80	12.00	10.92
M 14	13.97	14.20	13.77	14.00	12.77
M 16	15.97	16.20	15.77	16.00	14.77

TAPTITE 2000® thread dimensions

Thread	C	D	CP max
	nominal	normal	
M 2	2.00	1.96	1.77
M 2.5	2.50	2.45	2.25
M 3	3.00	2.95	2.71
M 3.5	3.50	3.44	3.17
M 4	4.00	3.93	3.60
M 5	5.00	4.92	4.55
M 6	6.00	5.90	5.38
M 8	8.00	7.87	7.23
M 10	10.00	9.85	9.08
M 12	12.00	11.82	10.92
M 14	14.00	13.80	12.77
M 16	16.00	15.80	14.76

Blind holes: Guide values for insertion and tightening torque for TRIFORM™, TAPTITE II®, DUO-TAPTITE® AND TAPTITE 2000® in Nm

Blind hole												
	M 2	M 2.5	M 3	M 3.5	M 4	M 5	M 6	M 8	M 10	M 12	M 14	M 16
Insertion torque** Values in Nm	0.1-0.2	0.2-0.4	0.3-0.7	0.5-1.1	0.7-1.6	1.5-3.5	2.5-8	7-15	15-30	25-52	35-70	55-115
Tightening torque 8.8*	0.4	0.8	1.5	2.2	3.3	6.4	11.6	27.3	53.6	91.4	152.3	231.0
Tightening torque 10.9	0.6	1.2	2.1	3.2	4.7	9.3	16.3	38.9	78.8	134.4	220.5	336.0
Tightening torque 12.9	0.8	1.4	2.4	3.7	5.5	10.9	18.9	45.2	91.4	157.5	252.0	399.0

Because of the many factors that can influence the process, such as mating thread material, hole diameter, thread reach, screw surface, lubrication conditions and screw geometry, the values shown are only intended as an approximate guide. The stated torque values apply only to screws with the corresponding hole geometry and sufficient thread reach.

Optimum assembly instructions must be determined by experiment.

* The values shown for 8.8 screws also apply to DIN 7500 screws.

** Even the highest insertion torque values are less than the maximum limits defined by DIN 7500.

TECHNICAL DATA – FOR METAL COMPONENTS

The tables shown here provide thread dimensions, suggestions for hole geometry for drilling, punching or casting, and guide values for insertion and tightening torque. The guide values shown apply equally to TRIFORM™, TAPTITE II®, DUO-TAPTITE® and TAPTITE 2000®. Due to the variety of possible parameters for material performance, surface and lubrication, the torque values stated should be regarded as guide values only. In case of critical component combinations such as low thread reach and mating thread materials of low ductility, we urgently recommend experimenting to determine the right values.

Materials and versions

TRIFORM™, TAPTITE II®, DUO-TAPTITE® and TAPTITE 2000® are available in the following materials: case-hardened to DIN EN ISO 7085, CORFLEX® N quenched and hardened with controlled recarborization to DIN EN 20898 (strength classes 8.8, 10.9 and 12.9) and CORFLEX® I with inductively hardened thread-forming crest.

A case-hardened version is sufficient for general applications with no special requirements for dynamic strength or ductility of the screw. Quenched and tempered screws of strength class 8.8, 10.9 or 12.9 are ideal for forming mating threads in light metals (CORFLEX® N, mating thread strength up to approx. 400 MPa or hardness 120 HB). Quenched and tempered screws with inductively hardened thread-forming crests (CORFLEX® I) are capable of forming mating threads in metals with strengths of up to approx. 650 MPa (200 HB) and meet the highest requirements for ductility and stress resistance.

The CORFLEX® versions enable thread-forming screws to be used for fastenings subject to high static and dynamic loads.

Rim holes in sheet metal: Guide values for hole diameter d_B TRIFORM™, TAPTITE II®, DUO-TAPTITE® and TAPTITE 2000® in mm

Thickness s (mm)	M 2.5	M 3	M 3.5	M 4	M 5	M 6	M 8	M 10	M 12
0.5	2.21 - 2.24	2.68 - 2.71							
0.8	2.23 - 2.26	2.71 - 2.74	3.15 - 3.18						
1.0	2.25 - 2.28	2.74 - 2.77	3.16 - 3.21	3.57 - 3.62	4.48 - 4.54				
1.5	2.27 - 2.30	2.77 - 2.80	3.19 - 3.24	3.60 - 3.65	4.51 - 4.57	5.38 - 5.45	7.19 - 7.27		
2.0				3.64 - 3.69	4.54 - 4.60	5.41 - 5.48	7.22 - 7.30	9.08 - 9.17	
3.0					4.57 - 4.63	5.44 - 5.51	7.25 - 7.33	9.13 - 9.22	10.90 - 11.00
4.0							7.30 - 7.38	9.18 - 9.27	10.95 - 11.05
5.0								9.26 - 9.35	11.00 - 11.10

Geometry of holes as per diagram; cf. DIN 7952. A material with a high elongation at rupture must be used to ensure holes without cracks. Guide value for pilot hole in sheet metal: 0.5 x nominal diameter of screw.

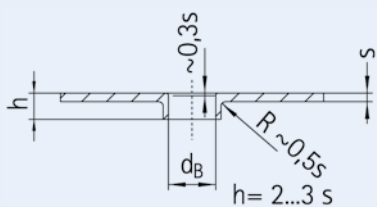

Cast holes: Guide values for hole diameter

TRIFORM™, TAPTITE II®, DUO-TAPTITE® and TAPTITE 2000® in mm

Dimensions in mm	M 4	M 5	M 6	M 8	M 10	M 12	M 14	M 16
d_o	3.73	4.72	5.66	7.60	9.55	11.50	13.45	15.45
d_u	3.55	4.50	5.40	7.26	9.13	11.00	12.80	14.80
Upper gap for d_o and d_u^*	+ 0.030	+ 0.030	+ 0.036	+ 0.036	+ 0.043	+ 0.043	+ 0.043	+ 0.043
d_s^*	6.50	8.50	10.00	13.00	17.00	20.00	24.00	27.00
t_s	0.70	0.80	1.00	1.30	1.50	1.80	2.00	2.00
d_s	4.20	5.20	6.30	8.30	10.40	12.40	14.50	16.50
Upper gap for d_s, t_s, d_s^*	+ 0.075	+ 0.075	+ 0.090	+ 0.090	+ 0.110	+ 0.110	+ 0.110	+ 0.110
l for high-strength materials, e.g. cast steel a approx. 1.5°	6.70	8.30	9.80	12.80	16.40	19.50	21.70	25.00
l for medium-strength materials, e.g. gray cast iron, aluminum, zinc, a approx. 1.1°	8.20	10.30	12.40	16.40	20.50	24.50	28.70	33.00
l for low-strength materials, e.g. magnesium, aluminum, a approx. 0.8°	12.40	15.40	18.50	24.50	30.70	36.80	43.00	49.00

* Larger tolerances, different external diameters of the casting dome or different tapers may be used if the proof load requirements for the fastening are less demanding.

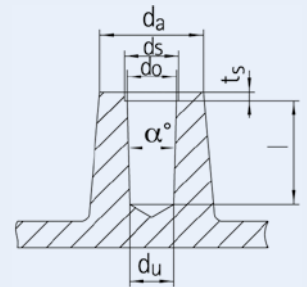

Cylindrical holes: Guide values for hole diameter d_b

TRIFORM™, TAPTITE II®, DUO-TAPTITE® and TAPTITE 2000® in mm

Thread reach / Material thickness s (mm)	M 2	M 2.5	M 3	M 3.5	M 4	M 5	M 6	M 8	M 10	M 12	M 14	M 16
0.5 - 1.0	1.80	2.25	2.70									
1.0 - 1.6	1.80	2.25	2.70	3.20								
1.6 - 2.5	1.85	2.25	2.75	3.20	3.65	4.50	5.40					
2.5 - 4.0	1.85	2.30	2.75	3.20	3.65	4.55	5.50	7.30	9.30			
4.0 - 6.3		2.30	2.75	3.25	3.70	4.65	5.50	7.40	9.30	11.10		
6.3 - 10.0					3.70	4.65	5.55	7.50	9.40	11.10		
10.0 - 16.0								7.50	9.40	11.20	13.20	15.20
16.0 - 25.0								7.60	9.50	11.30	13.20	15.20
Upper gap of hole (mm)		+ 0.050	+ 0.075	+ 0.075	+ 0.075	+ 0.075	+ 0.090	+ 0.090	+ 0.110	+ 0.110	+ 0.110	+ 0.110

Larger hole diameters reduce the insertion torque, smaller diameters increase the durability of the mating thread and the resistance to loosening. For malleable, low-strength materials such as aluminum alloys, the hole diameters can be reduced by approx. 0.05 mm. Hole tolerances: H11 to DIN ISO 286.

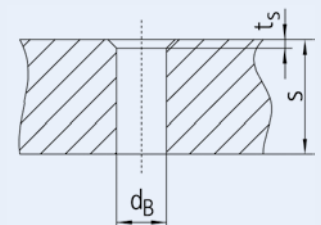

THREAD-FORMING SCREWS – FOR SHEET METAL COMPONENTS

TRIFORM™ DB, EXTRUDE-TITE® and TRIFORM™ DB HF are thread-forming screws with a particularly long thread-forming crest for use with sheet metals. They form their own rim hole if the diameter of the drilled hole is suitably reduced. This enables a fastening with a high proof load to be produced even in very thin sheet metal materials by plastic reforming of the mating thread material. The long thread-forming crest produces a marked axial alignment of the screw during assembly. In contrast to conventional sheet metal screws, the large web section facilitates considerable reforming of the mating thread material with increased stripping torque. The TRIFORM™ DB HF is a special screw developed specifically for high-strength sheet metals. The usual thin sheet screws are suitable for sheet metals up to max. 600 MPa. Higher strengths make it more difficult for the screw to engage or the screw is heavily damaged due to the small differences in strength. The use of normal thin sheet screws in stainless steel sheets has also been limited until now because of the poor friction pairings. The TRIFORM™ DB HF now makes thread-forming fastening possible in sheet metals with a strength of 600 MPa to 950 MPa and in stainless steel sheets.

TRIFORM™ DB

- High axial proof load
- Round cross-section
- Cost-effective

TRIFORM™ DB

The screw is based on the tried and tested TRIFORM™ geometry and is a high-performance fastener at low cost. This high performance is achieved by the forming surfaces on the thread-forming crest and the cylindrical screw shank. The flanks of the thread are fully formed right through to the crest. The TRIFORM™ DB screw can be used wherever maximum cost-effectiveness is required for sheet metal components.

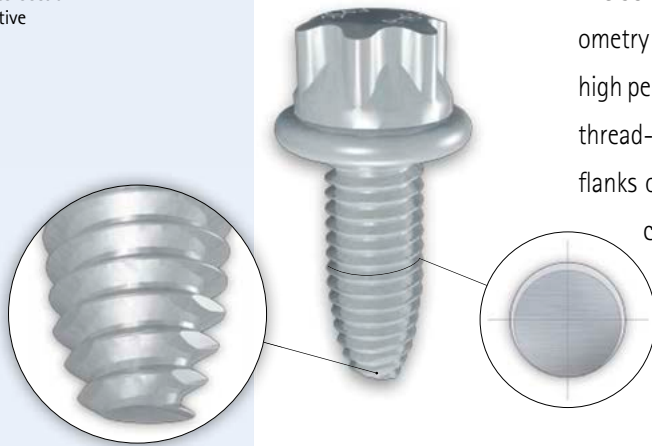

EXTRUDE-TITE®

The EXTRUDE-TITE® screw is slightly out-of-round along the full length of the shank. This also achieves very low insertion torque in sheet metals, which provides maximum assembly reliability even in difficult applications. The thread flanks of the EXTRUDE-TITE® screw are also fully formed through to the crest.

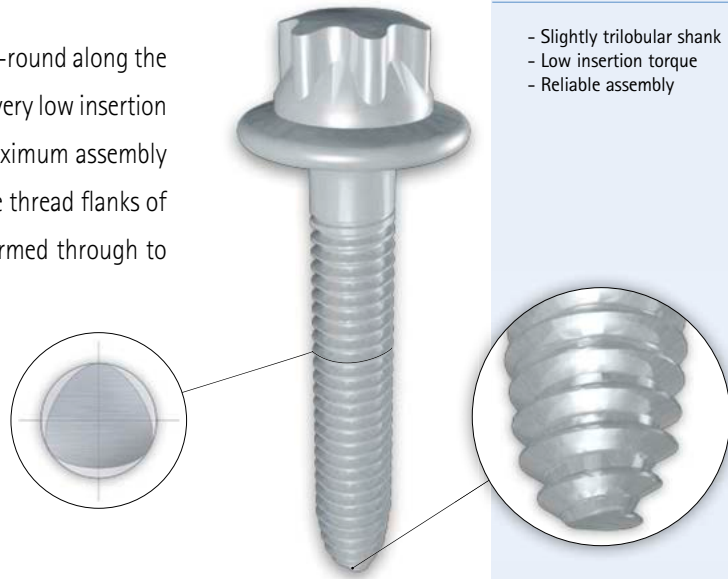

EXTRUDE-TITE®

- Slightly trilobular shank
- Low insertion torque
- Reliable assembly



TRIFORM™ DB HF

Changing the heat treatment and the geometry below the screw head makes this screw with the proven TRIFORM™ geometry suitable for use in high-strength and stainless sheet metals. The TRIFORM™ DB HF is made of quenched and tempered low-alloy steel. The thread crest is inductively hardened. The corrosion protection is designed for high surface pressure on inserting into hard sheet metals.

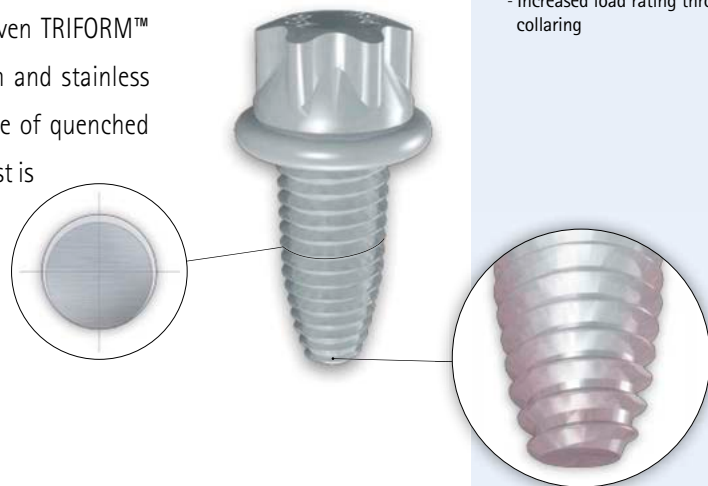

TRIFORM™ DB HF

- For sheet metals up to 950 MPa tensile strength and austenitic sheet metals
- Increased load rating through more collaring





TECHNICAL DATA – FOR SHEET METAL COMPONENTS

The following three main parameters are important for direct fastening in sheet metals:

- The diameter of the pilot hole in the component
- The insertion torque expected during assembly
- The tightening torque that can be safely applied

These three parameters are shown in the following tables.

For direct fastening in sheet metals, the component is practically always the weak point when the fastening is overstressed. The assembly instructions must therefore be carefully prepared. Because of the many factors that can influence the process, the values given in the tables are only guide values and should be checked in each case.

Modern assembly methods with several screw levels also help to ensure reliable assembly for direct fastening in sheet metals. They even allow screws to be reliably assembled when the insertion torque exceeds the tightening torque. This means the right screw combined with the right assembly method can open up additional applications and potential cost savings for fastening in sheet metals.

The tables shown here provide thread dimensions, suggestions for hole geometry for drilling and punching, and guide values for insertion and tightening torque. The guide values apply equally to TRIFORM™ DB, TRIFORM™ DB HF and EXTRUDE-TITE®. Due to the variety of possible parameters for material performance, surface and lubrication, the torque values stated should be regarded as guide values only. In case of critical component combinations such as low thread reach and mating thread materials of low ductility, we urgently recommend experimenting to determine the right values.

TRIFORM™ DB and TRIFORM™ DB HF thread dimensions			
Thread	d ₂ max	z max	d ₁ max
M 3	1.50	3.50	3.10
M 4	2.00	4.90	4.12
M 5	2.50	5.60	5.12
M 6	3.00	7.00	6.12
M 8	4.40	8.80	8.16

TRIFORM™ DB
TRIFORM™ DB HF

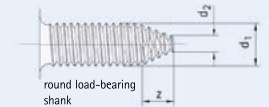

EXTRUDE-TITE® thread dimensions						
Thread	C		D		CP max	LP max
	min	max	min	max		
M 3	2.98	3.07	2.93	3.02	1.26	2.75
M 4	3.98	4.08	3.91	4.01	1.56	3.85
M 5	4.98	5.09	4.90	5.01	2.21	4.40
M 6	5.97	6.10	5.87	6.00	2.51	5.50
M 8	7.97	8.13	7.85	8.01	3.64	6.88

EXTRUDE-TITE®

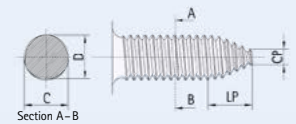

Hole diameters and torque values: TRIFORM™ DB, EXTRUDE-TITE®

Thickness s (mm)	Hole diameter (mm)				Insertion torque guide values (Nm)				Tightening torque guide values (Nm)			
	M 3	M 4	M 5	M 6	M 3	M 4	M 5	M 6	M 3	M 4	M 5	M 6
0.75	1.8	2.4	3.5		0.5	1.3	2.0		0.8	2.5	4.0	
0.80	1.8	2.4	3.6	4.6	0.5	1.4	2.0	2.3	0.9	2.5	4.5	5.0
0.90	1.8	2.4	3.8	4.7	0.6	1.4	2.1	2.5	1.0	2.5	5.0	6.0
1.00	2.0	2.5	3.9	4.8	0.6	1.6	2.2	2.7	1.1	3.0	5.0	6.0
1.25	2.2	2.7	4.1	4.9	0.7	1.6	2.3	3.0	1.2	3.0	5.0	7.0
1.50		2.9	4.2	5.0		1.7	2.5	3.2		3.0	5.0	8.0
2.00		3.1	4.3	5.1		1.8	2.7	3.6		3.5	6.0	10.0
2.50			4.5	5.2			2.9	3.9			6.0	10.0

The values given refer to cylindrical holes without rims. Due to the many factors that influence the process, the approximate values given here may vary in individual cases (materials, surface, lubrication, bearing face diameter).

THREAD-FORMING SCREWS – FOR MAGNESIUM COMPONENTS

Magnesium is the lightest metal construction material and is gaining strongly in importance due to its extremely low density and almost unlimited availability as a raw material. A variety of cast magnesium components are already used in automotive engineering and other industries. This results in new requirements for fastening systems with regard to prestressing force losses due to the low creepage resistance of commercial cast magnesium alloys, susceptibility to contact corrosion compared with fasteners of steel materials, and implementation of light construction designs for fasteners too.

The use of high-strength RIBE® ALUFORM® aluminum screws is the optimum solution for reliable fastening of magnesium components. Prestressing force losses due to additional thermally induced stresses are minimized by the very similar coefficients of thermal expansion, contact corrosion is avoided almost completely even with uncoated screws, and the necessary thread reach can be reduced with optimized assembly.

ALUFORM® thread-forming screws

- No contact corrosion
- Minimum prestressing force losses due to similar thermal expansion
- Weight reduction
- Reduced minimum thread reach



ALUFORM® thread-forming screws

The ALUFORM® thread-forming screws described on the preceding pages are used in magnesium components. The screw material and geometry are based on the specific application and especially on the strength/ductility of the magnesium alloy used:

- ALUFORM® thread-forming screw of optimized, heat-treated ALUFORM® series material with a tensile strength of $R_m > 420$ MPa
- ALUFORM®-PLUS thread-forming screw of ALUFORM® T9 series material with a tensile strength of $R_m > 500$ MPa
- ALUFORM®-HF thread-forming screw of high-strength AlZnMgCu T79 material with a tensile strength of $R_m > 550$ MPa

THREAD-FORMING SCREWS – FOR PLASTIC COMPONENTS

Plastic components are light and inexpensive. The most suitable fasteners for plastics are screws that can be screwed directly into the plastic without a mating thread. Out-of-round screws are not necessary because of the great flexibility of plastics. The threads of these screws have a relatively coarse pitch and a small body diameter to achieve high pullout forces.

RIBE® PR

The RIBE® PR thread profile has been developed for fastening applications with medium requirements at low cost. The screw has narrow 30° flanks which provide good engagement between the screw and the formed mating thread in plastic materials. The body diameter is chosen so that the plastic is generally not compressed right to the root of the thread.

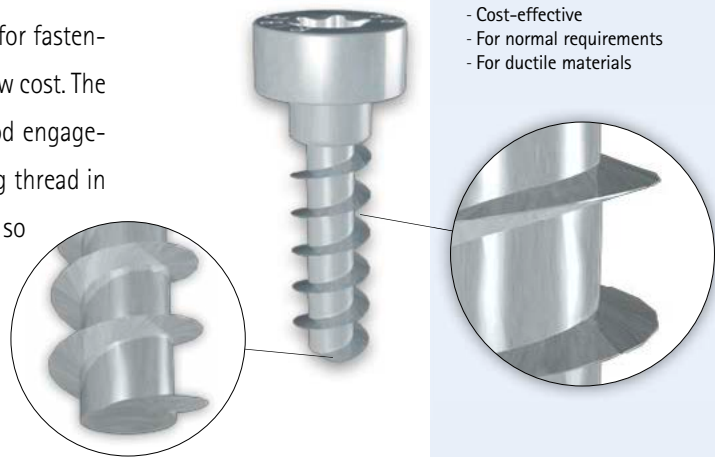

- Cost-effective
- For normal requirements
- For ductile materials

RIBE® PR

PLASTOFORM

The PLASTOFORM thread profile has been optimized by computer modeling and experimental studies so that the same screw can be used for fastening both ductile and brittle plastics. The screw geometry is designed particularly for low insertion torque. The component material is compressed through the curves so that high pullout forces result. The PLASTOFORM geometry also optimizes the radial stress in the plastic, which reduces the risk of splitting the screw dome. The screw can also withstand a high dynamic load.

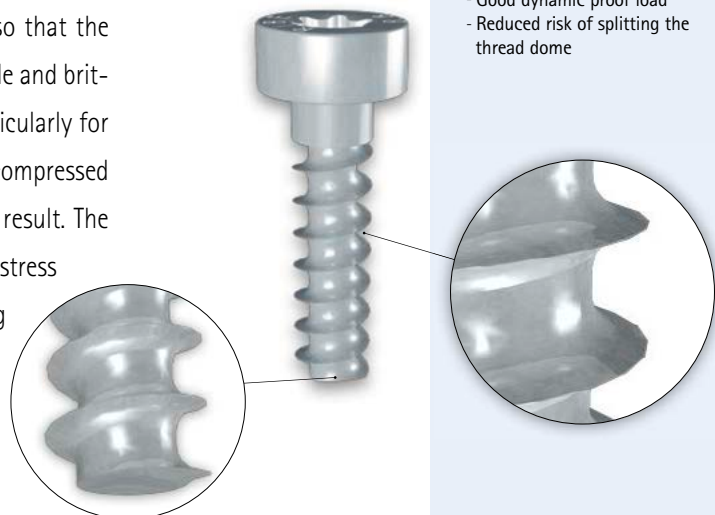

- Also suitable for brittle plastics
- High pullout forces
- Good dynamic proof load
- Reduced risk of splitting the thread dome

PLASTOFORM

TECHNICAL DATA – FOR PLASTIC COMPONENTS

The starting point for correctly sizing a direct fastening in plastic is the required clamping force, which is limited by the maximum fracture force of the screw. This determines the required screw dimensions. The tables on the right show guide values for each screw dimension for the required hole diameters and for the expected values of insertion and tightening torque.

The stress resistance of the plastic determines the necessary thread reach. The most frequently used plastics are listed in the table below. Using the permissible stress shown in the table, the corresponding thread reach and external diameter of the screw dome can be read from the diagram. These values together with suggestions for a screw enclosure enable the screw geometry and the component fastening area to be determined rapidly. For special fastening requirements, these guide values should be checked by experiment and optimized if necessary.

Guidelines for the sizing of direct fasteners in plastic

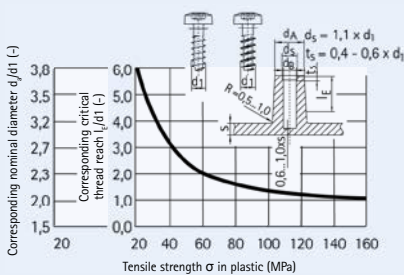

Permissible stresses: Guide values in plastic

Plastic	(MPa)
ABS	50
EP epoxy resin	65 – 110
PA6 dry – rel. humidity 3% H ₂ O	30 – 85
PA6 GF30 dry – rel. humidity 3% H ₂ O	100 – 170
PA6 GF50 dry – rel. humidity 3% H ₂ O	120 – 190
PA66 dry – rel. humidity 2.5% H ₂ O	60 – 85
PC	60
PC GF30	80
PE	30
POM	65
PP	30
PUR	50
PVC hard	65
SAN	70
UP	75

The permissible stress is derived from the yield stress, 1% extension stress or the fracture strength, depending on the material properties of the plastic. The values given are guide values for a quick estimate. For low-relaxation fastenings, the permissible stress should be reduced by a factor of 0.5 – 0.8.

RIBE® PR thread dimensions										
Thread	PR 1.8	PR 2.0	PR 2.2	PR 2.5	PR 3.0	PR 3.5	PR 4.0	PR 5.0	PR 6.0	PR 7.0
a	1.30	1.40	1.50	1.70	1.90	2.10	2.40	3.00	3.60	4.20
b	7.00 ^{+1.1}	8.00 ^{+1.3}	9.00 ^{+1.4}	10.00 ^{+1.6}	12.00 ^{+1.9}	14.00 ^{+2.3}	16.00 ^{+2.7}	20.00 ^{+3.2}	24.00 ^{+3.8}	28.00 ^{+4.5}
d ₁ (h13)	1.95	2.15	2.35	2.65	3.15	3.65	4.15	5.15	6.15	7.20
d ₂ (h12)	1.20	1.32	1.43	1.60	1.90	2.18	2.48	3.04	3.63	4.20
d ₃	1.50	1.60	1.70	1.90	2.30	2.60	3.00	3.60	4.25	4.50
P	0.80	0.91	0.98	1.12	1.34	1.57	1.79	2.24	2.69	3.14
x max	0.80	0.90	1.00	1.20	1.40	1.60	1.80	2.20	2.70	3.20
y max	0.80	0.90	1.00	1.20	1.40	1.60	1.80	2.20	2.70	3.20

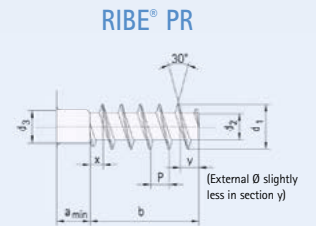

PLASTOFORM thread dimensions								
Thread	P 3.0	P 3.5	P 4.0	P 4.5	P 5.0	P 5.5	P 6.0	P 6.5
a	1.30 ^{+0.50}	1.50 ^{+0.50}	1.80 ^{+0.60}	1.80 ^{+0.70}	2.20 ^{+0.80}	2.40 ^{+0.80}	2.50 ^{+0.90}	2.90 ^{+1.00}
b	12.00 ^{+1.90}	14.00 ^{+2.30}	16.00 ^{+2.70}	18.00 ^{+2.60}	20.00 ^{+3.20}	22.00 ^{+3.50}	24.00 ^{+3.80}	26.00 ^{+4.30}
d ₁	3.00 _{-0.20}	3.50 _{-0.20}	4.00 _{-0.25}	4.50 _{-0.25}	5.00 _{-0.25}	5.50 _{-0.25}	6.00 _{-0.25}	6.50 _{-0.25}
d ₂	1.87 _{-0.20}	2.03 _{-0.20}	2.50 _{-0.20}	2.70 _{-0.25}	2.96 _{-0.25}	3.35 _{-0.25}	3.64 _{-0.25}	3.83 _{-0.25}
P	1.27	1.53	1.78	1.84	2.15	2.35	2.54	2.87
x max	1.30	1.60	1.80	1.90	2.20	2.40	2.60	2.90
y max	1.30	1.60	1.80	1.90	2.20	2.40	2.60	2.90

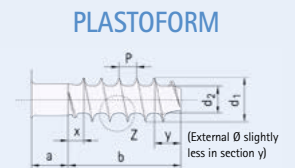

Characteristic values for PLASTOFORM and RIBE® PR screws											
Type			P 3.00	P 3.50	P 4.00	P 4.50	P 5.00	P 5.50	P 6.00	P 6.50	
	PR 2.00	PR 2.50	PR 3.00	PR 3.50	PR 4.00		PR 5.00		PR 6.00		PR 7.00
Nominal diameter d ₁ (mm)	2.00	2.50	3.00	3.50	4.00	4.50	5.00	5.50	6.00	6.50	7.00
Min. screw fracture force (kN)	0.95	1.40	1.75	2.10	3.30	3.80	4.60	6.00	7.20	8.10	9.50
d _B ductile plastic (mm)*	1.60	2.00	2.40	2.80	3.40	3.80	4.20	4.60	5.10	5.50	5.50
d _B brittle plastic (mm)*	1.80	2.10	2.60	3.00	3.60	4.00	4.50	5.00	5.40	5.90	5.90
Insertion torque M _E approx. (Nm)	0.10	0.20	0.50	0.70	0.80	1.20	1.50	2.00	3.00	4.00	5.00
Tightening torque M _A approx. (Nm)	0.25	0.50	1.00	1.40	1.60	2.40	3.00	4.50	6.00	8.00	10.00

The values given are guide values as many parameters influence the process (e.g. materials, surfaces, geometry, assembly conditions). Optimized fastenings usually require adaptation of d_B, I_E and d₃.

* Hole tolerance +0.05 mm.

SPECIAL CASES THREAD LOCKING / CLEANING

KLEERTITE

KLEERTITE screws are TAPTITE® screws with a special paint removal crest for "soiled" pilot holes. They are used as thread-forming screws in applications such as painted pilot holes or as fixing screws in soiled mating threads. One of the main applications for these screws is for ground connections.

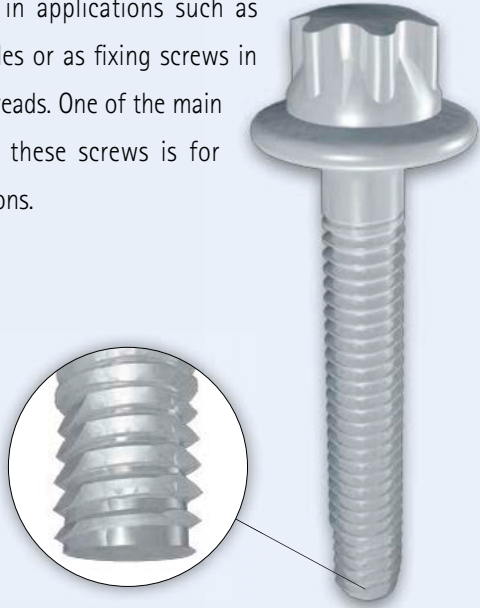

KLEERLOK

KLEERLOK screws are based on the POWERLOK geometry and have a special paint removal crest for cleaning existing "soiled" mating threads. This eliminates the need for expensive plugging to protect the mating thread. The screw geometry also provides a metallic captive function, which allows rapid and reliable assembly under constant torque and prestressing force conditions and distinctly reduces assembly costs.

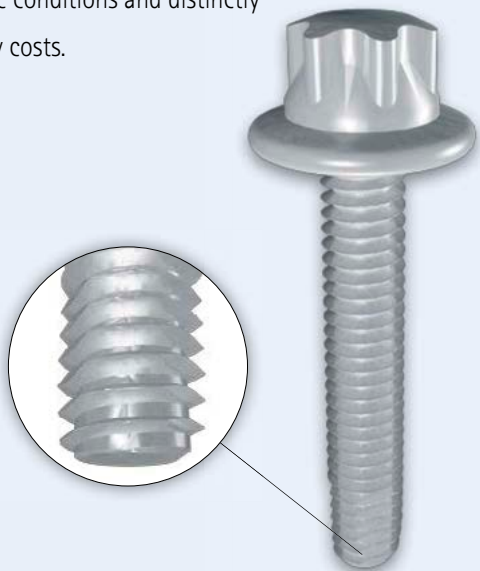

SPECIAL CASES THREAD LOCKING / CLEANING

RIBE® offers special screws with a trilobular shank geometry and additional features like thread locking and thread cleaning for use in existing metric mating threads and for cleaning "soiled" pilot holes. If metric mating threads are available, the trilobularity has a similar effect to thread forming and reduces the insertion torque under difficult assembly conditions, which provides additional clamping forces by reforming the root of the mating thread (POWERLOK). KLEERLOK screws remove existing soiling like dirt or paint when they are screwed in. This eliminates applying additional adhesive thread coatings and extra work, which can make a significant contribution to minimizing the total fastening costs.

POWERLOK

POWERLOK screws are trilobular securing screws for existing metric mating threads. Reducing the flank angle in the area of the thread crest ($60^\circ \rightarrow 30^\circ$) and increasing the external diameter results in elastic reforming at the thread crest of the screw and at the body diameter of the mating thread during assembly. This produces the clamping effect in the thread, which is largely reversible due to the elastic nature and is therefore also suitable for repeated assembly.

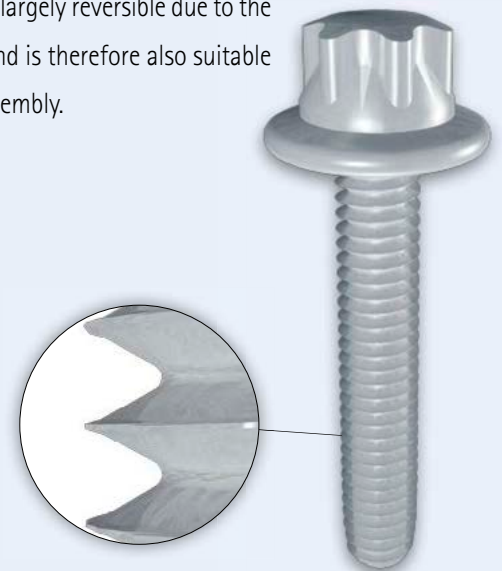

RIBE®

MADE TO **fit**

Richard Bergner Verbindungstechnik GmbH & Co. KG
Bahnhofstr. 8-16 · 91126 Schwabach · Germany
Telephone +49 (0) 91 22 / 87-0 · Fax +49 (0) 91 22 / 87-1537
E-Mail Verbindungstechnik@ribe.de · Internet www.ribe.de

A member company of

"Connecting The World"